

PART DESCRIPTION : Extension Nipple 2-1/2"

CAT NO. : F850103CP

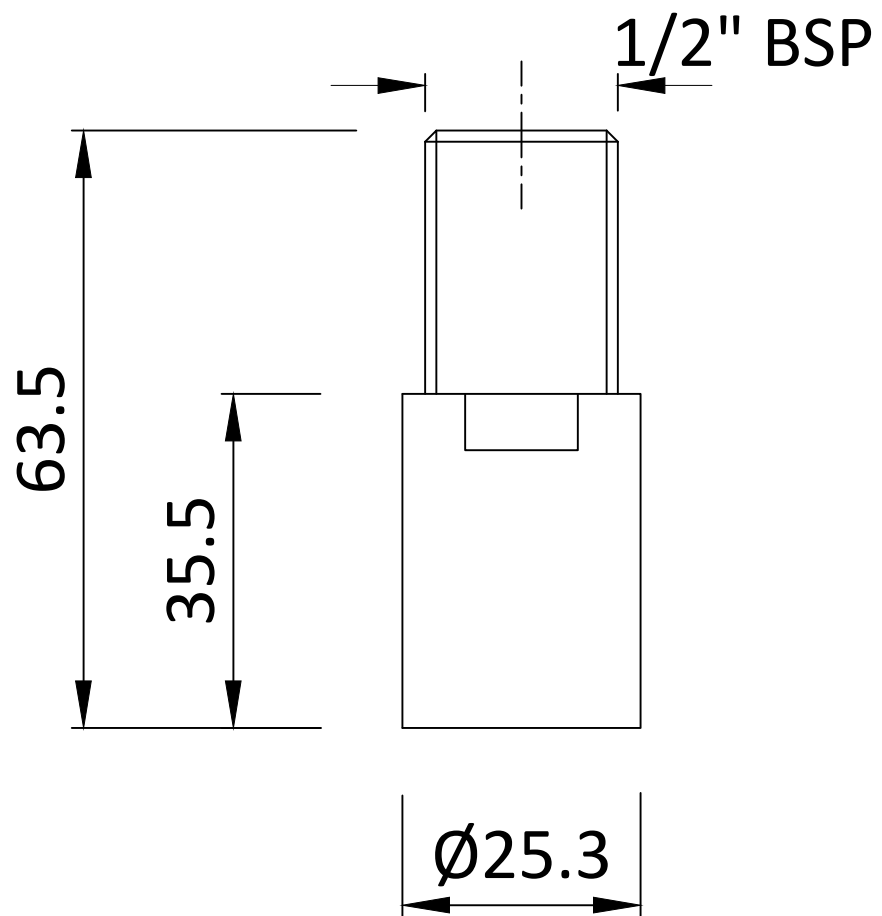
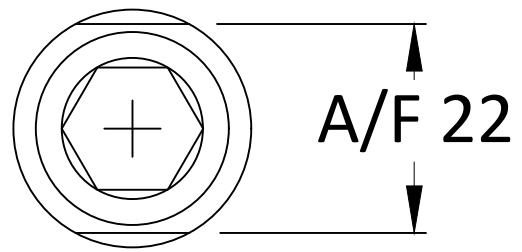

RSC